

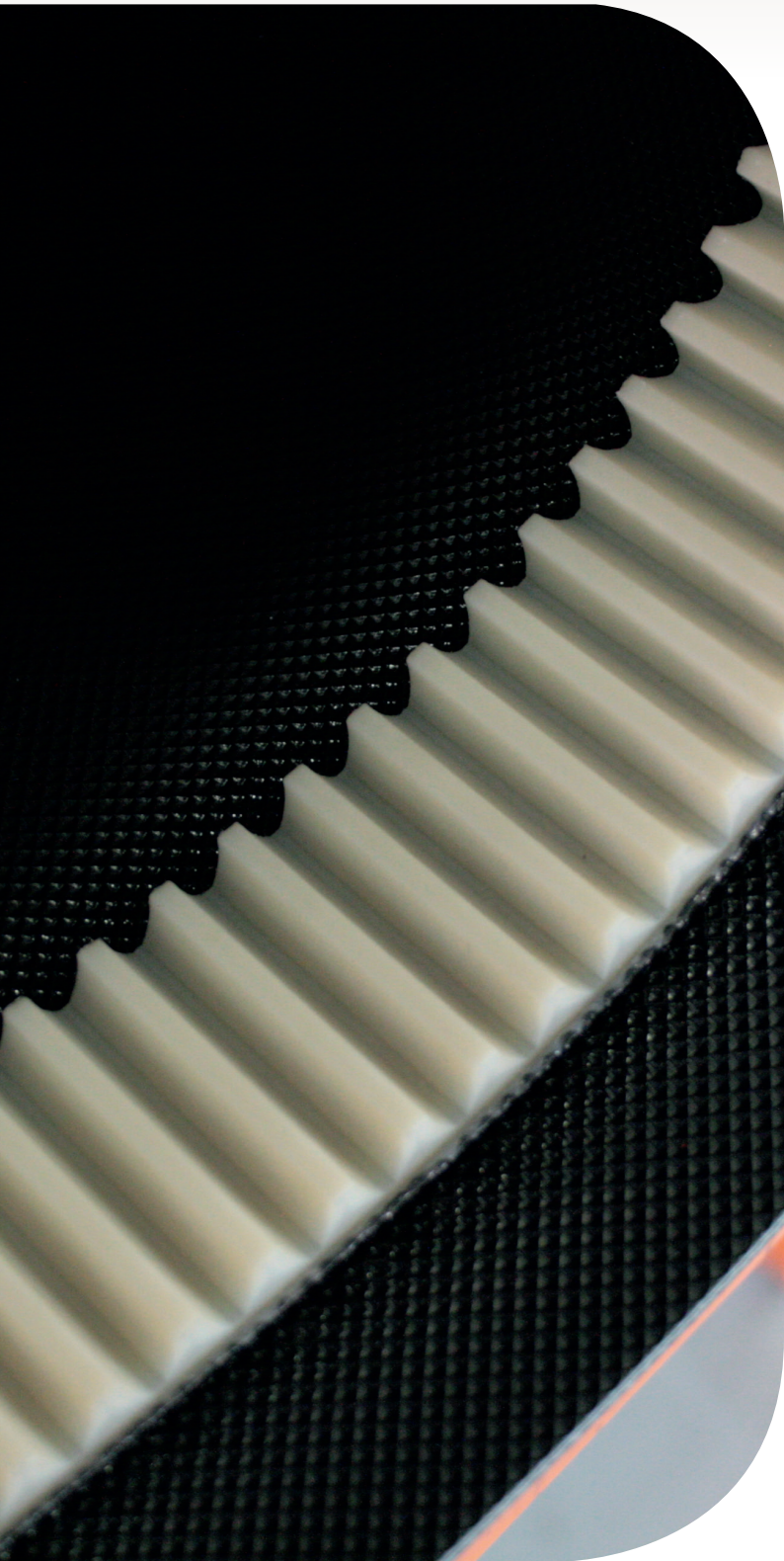

SYNTHETIC CONVEYOR BELTS
GUIDE ROPES AND STRIPS



endless in service and innovation



LBS Emmen has a large and wide range of guide ropes and strips in various shapes, sizes, colours and qualities. These guides and strips ensure that the belt remains stable and steady with an irregular burden and/or irregular loading.

Possible causes of an unstable and irregular belt operation:

- Uneven load
- Soiling
- One-sided loading
- Transport at an angle
- Temperature differences

In this document you will find additional information about the complete range of guide ropes and strips that LBS Emmen has to offer.

Colourindex

- Green
- White
- Blue
- Petrol
- Black
- Transparent
- Broken white

V-guides

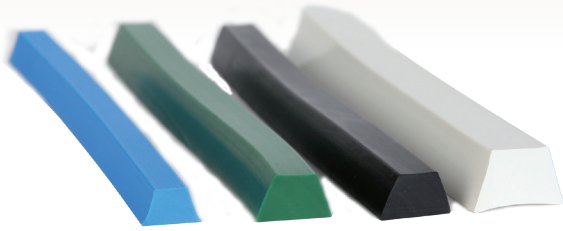

V-Guides

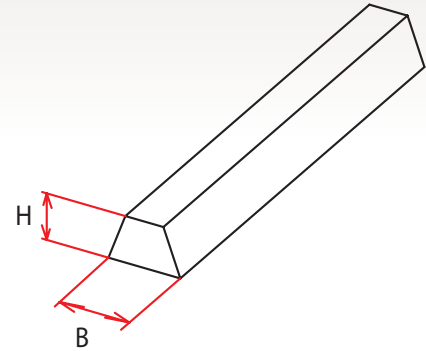

V-guide PVC

Type	Height (H)	Width (B)	Available colours	Min. Drum ϕ
V6x4	4 mm	6 mm		25 mm
V8x5	5 mm	8 mm		30 mm
V10x6	6 mm	10 mm		40 mm
V13x8	8 mm	13 mm		50 mm
V17x11	11 mm	17 mm		70 mm
V22x14	14 mm	22 mm		85 mm
V30x16	16 mm	30 mm		100 mm

Blue and white suitable for unpackaged foods

The minimum drum diameter depends in part on the base belt and the type of material

Displayed values only for confection lengthwise on the bottomside

Other ready-for-use options and colours on request

V-guide PU

Type	Height (H)	Width (B)	Available colours	Min. Drum ϕ
VU8x5	5 mm	8 mm		60 mm
VU10x6	6 mm	10 mm		70 mm
VU13x8	8 mm	13 mm		90 mm
VU17x11	11 mm	17 mm		100 mm

Blue, white and transparent suitable for unpackaged foods

The minimum drum diameter depends in part on the base belt and the type of material

Displayed values only for confection lengthwise on the bottomside

Other ready-for-use options and colours on request

V-guide PE

Type	Height (H)	Width (B)	Available colours	Min. Drum ϕ
VE6x4	4 mm	6 mm		50 mm
VE8x5	5 mm	8 mm		60 mm
VE10x6	6 mm	10 mm		70 mm
VE13x8	8 mm	13 mm		90 mm
VE17x11	11 mm	17 mm		100 mm

Suitable for unpackaged foods

The minimum drum diameter depends in part on the base belt and the type of material

Displayed values only for confection lengthwise on the bottomside

Other ready-for-use options and colours on request

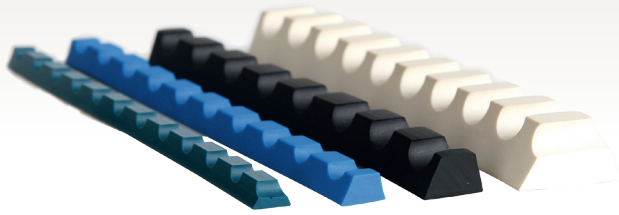

VK-guides

VK-guides

Type	Height (H)	Width (B)	PVC Available colours	Min. Drum Ø
VK8x5	5 mm	8 mm	■ ■ ■ ■	15 mm
VK10x6	6 mm	10 mm	■ ■ ■ ■	20 mm
VK13x8	8 mm	13 mm	■ ■ ■ ■	25 mm
VK17x11	11 mm	17 mm	■ ■ ■ ■	35 mm
VK22x14	14 mm	22 mm	■ ■ ■ ■	45 mm
VK30x16	16 mm	30 mm	■ ■ ■ ■	50 mm

Blue and white suitable for unpackaged foods

The minimum drum diameter depends in part on the base belt and the type of material

Displayed values only for confection lengthwise on the bottomside

Other ready-for-use options and colours on request

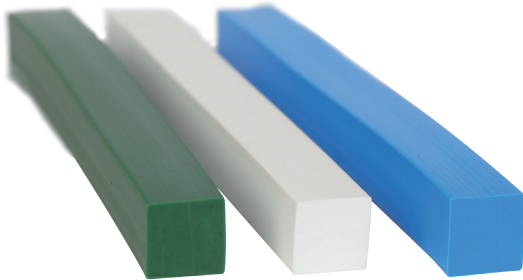

B-Blockguides

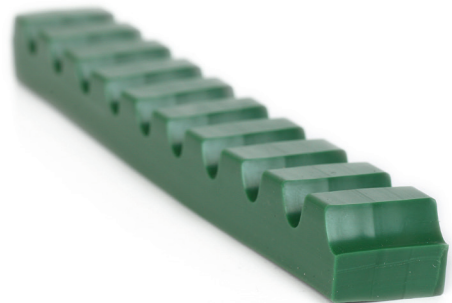

BK-Blockguides

Blockguides

Type	Height (H)	Width (B)	PVC Available colours	Min. Drum Ø
BG10x10	10 mm	10 mm	■ ■ ■ ■	80 mm
BG15x15	15 mm	15 mm	■ ■ ■ ■	120 mm
BG20x15	20 mm	15 mm	■ ■ ■ ■	150 mm
BK20x15	20 mm	15 mm	■ ■ ■ ■	140 mm

Blue and white suitable for unpackaged foods

Standard hardness BG (coated): 55° Shore A. Other hardness on request

The minimum drum diameter depends in part on the base belt and the type of material

Displayed values only for confection lengthwise on the bottomside

Other ready-for-use options and colours on request

Guide strips



Guide strip P11 - PVC



Guide strip P11 - Hytrel

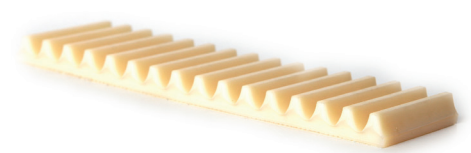

Modul 3 - Hytrel



Guide strip P11 - PE

Guide strips

Type	Thickness	Widths	Available colours	Min. Drum Ø
Guide strip P11 -PVC	5 mm	30 / 40 / 50 / 60 mm	■ ■ ■ ■	30 mm
Guide strip Smooth-PVC	3,5 mm	20 / 25 / 30 / 40 / 50 mm	■ ■ ■ ■	20 mm
Guide strip P11 -Hytrel	6 mm	40 / 50 mm	■	40 mm
Guide strip P11 -PE	6 mm	40 / 50 mm	■	40 mm
Modul 3	9 mm	On request (max. 225 mm)	■	40 mm

PVC: Blue and white suitable for unpackaged foods

Hytrel: Natural suitable for unpackaged foods

PE: Transparent suitable for unpackaged foods

The minimum drum diameter depends in part on the base belt and the type of material

Displayed values only for confection lengthwise on the bottomside

Other ready-for-use options and colours on request

PROBELL[®]

hotcleat[®]
POWERED BY LBS

Ecocleat[®]
BY LBS

MultiCutter[®]
BY LBS

Synthetic conveyor belts
Rubber conveyor belts
Synthetic modular belts and chains
Drive, timing and round belts
Synthetic gauze belts
Special endless belts
Components for belt conveyors
Technical rubber and synthetics
Service, installation and maintenance



endless in service and innovation



LBS
conveyor belts

LBS Emmen bv
Phileas Foggstraat 48
NL-7825 AL Emmen
The Netherlands

Phone +31 (0)591 668220
Fax +31 (0)591 668239
Internet www.lbs.cc
E-mail info@lbs.cc

The text and material published in this brochure serve a purely informative purpose, and have no official or legal status in the form they are published here. For further information please contact us.
00.465.472-Version 1